

FEATURES

- **WIDE FREQUENCY RESPONSE:** 3 GHz
- **HIGH GAIN:** 15 dB (UPC2708T)
- **SATURATED OUTPUT POWER:** +10 dBm (UPC2708T)
- **INTERNAL CURRENT REGULATION MINIMIZES GAIN CHANGE OVER TEMPERATURE**
- **5 V SINGLE SUPPLY VOLTAGE**
- **SUPER SMALL PACKAGE**
- **TAPE AND REEL PACKAGING OPTION AVAILABLE**

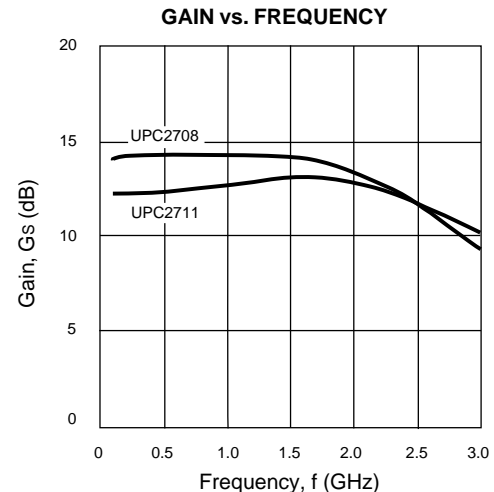

DESCRIPTION

The UPC2708T and UPC2711T are Silicon Monolithic integrated circuits manufactured using the NESAT III process. These devices are suitable as buffer amplifiers for wide-band applications. They are designed for low cost gain stages in cellular radios, GPS receivers, DBS tuners, PCN, and test/measurement equipment.

NEC's stringent quality assurance and test procedures ensure the highest reliability and performance.

ELECTRICAL CHARACTERISTICS (TA = 25 °C, f = 1 GHz, VCC = 5 V)

PART NUMBER PACKAGE OUTLINE			UPC2708T T06			UPC2711T T06		
SYMBOLS	PARAMETERS AND CONDITIONS	UNITS	MIN	TYP	MAX	MIN	TYP	MAX
I _{CC}	Circuit Current (no signal)	mA	20	26	33	9	12	15
G _s	Small Signal Gain	dB	13	15	18.5	11	13	16.5
f _u	Upper Limit Operating Frequency (The gain at f _u is 3 dB down from the gain at 0.1 GHz)	GHz	2.7	2.9		2.7	2.9	
ΔG _s	Gain Flatness, f = 0.1 - 2.6 GHz f = 0.1 - 2.5 GHz	dB		±0.8			±0.8	
P _{SAT}	Saturated Output Power	dBm	7.5	10		-2	1	
P _{1dB}	Output Power at 1 dB Compression Point	dBm		7.5			-4	
NF	Noise Figure	dB		6.5	8		5	6.5
RL _{IN}	Input Return Loss	dB	8	11		20	25	
RL _{OUT}	Output Return Loss	dB	16	20		9	12	
ISOL	Isolation	dB	18	23		25	30	
ΔG _T	Gain-Temperature Coefficient	dB/°C		+0.002			-0.002	
R _{TH}	Thermal Resistance (Junction to Ambient)	°C/W			200			200

UPC2708T, UPC2711T

ABSOLUTE MAXIMUM RATINGS¹ (T_A = 25°C)

SYMBOLS	PARAMETERS	UNITS	RATINGS
V _{CC}	Supply Voltage	V	6
P _{IN}	Input Power	dBm	+10
P _T	Power Dissipation ²	mW	280
T _{OP}	Operating Temperature	°C	-40 to +85
T _{STG}	Storage Temperature	°C	-55 to +150

Notes:

1. Operation in excess of any one of these parameters may result in permanent damage.
2. Mounted on 50 x 50 x 1.6 mm epoxy glass PWB (T_A = +85°C).

RECOMMENDED OPERATING CONDITIONS

SYMBOL	PARAMETER	UNITS	MIN	TYP	MAX
V _{CC}	Supply Voltage	V	4.5	5.0	5.5

TEST CIRCUIT

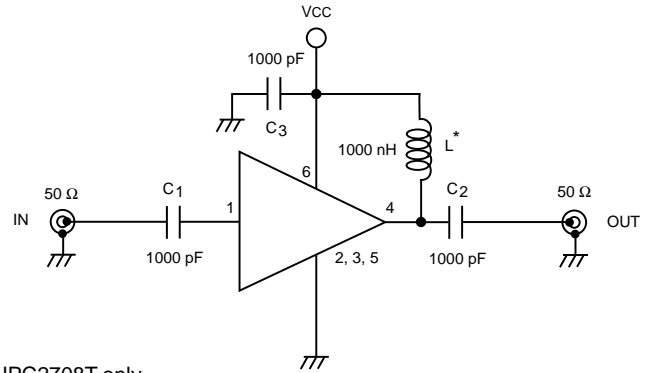

* UPC2708T only

TYPICAL PERFORMANCE CURVES (T_A = 25°C)

CIRCUIT CURRENT vs. VOLTAGE

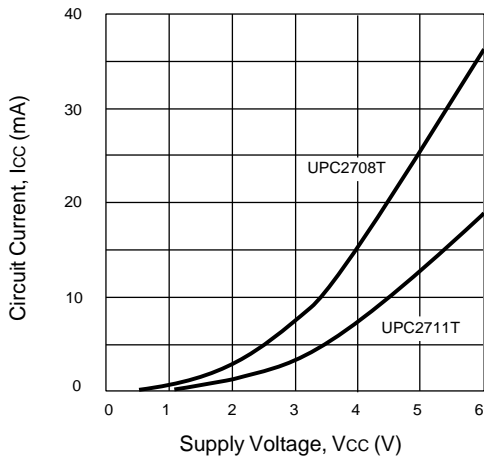

CIRCUIT CURRENT vs. TEMPERATURE

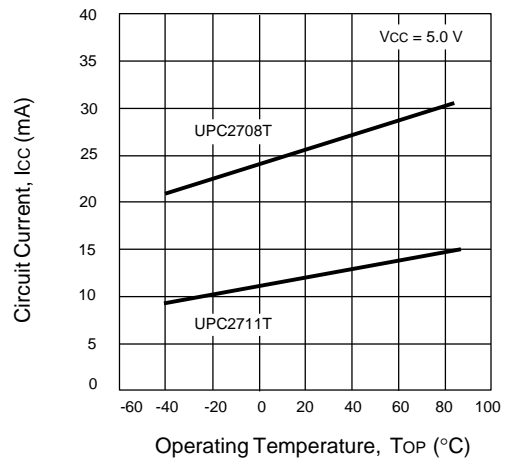

UPC2708T
GAIN AND NOISE FIGURE
vs. FREQUENCY AND VOLTAGE

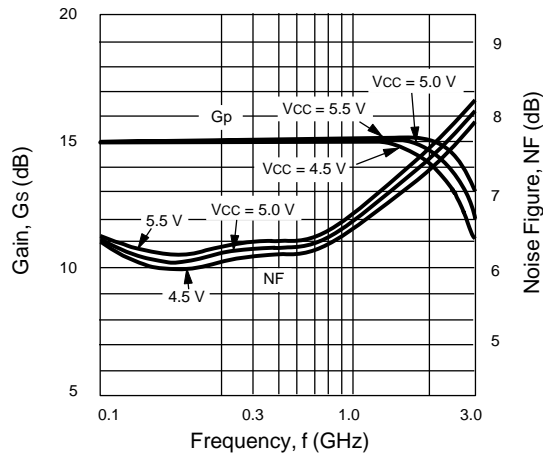

UPC2711T
GAIN AND NOISE FIGURE
vs. FREQUENCY AND VOLTAGE

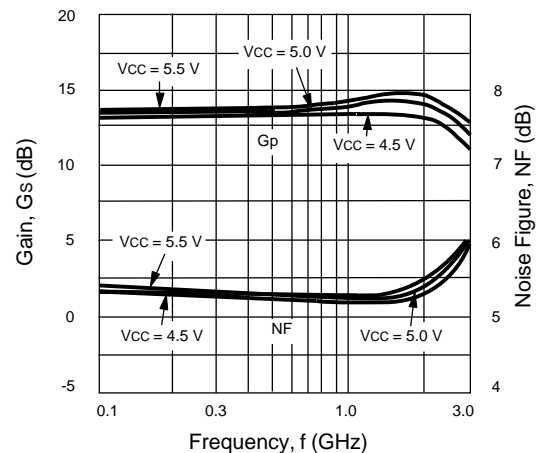

TYPICAL PERFORMANCE CURVES (T_A = 25°C)

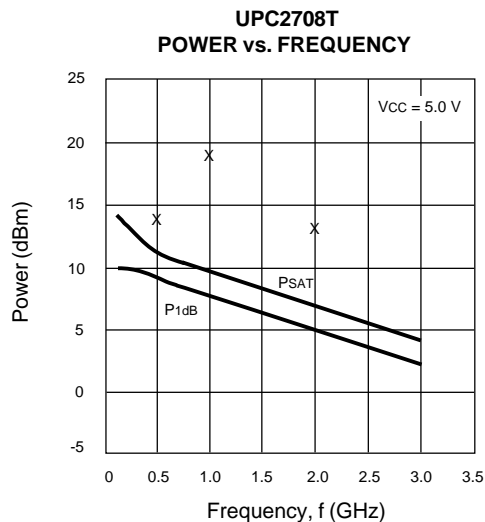
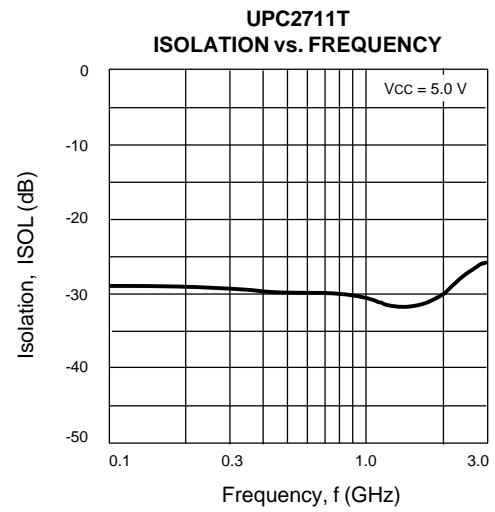
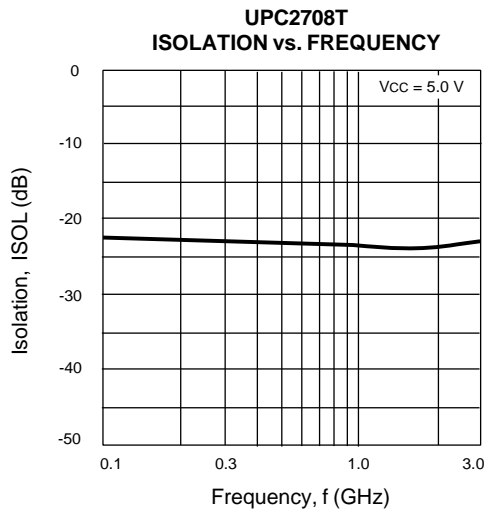
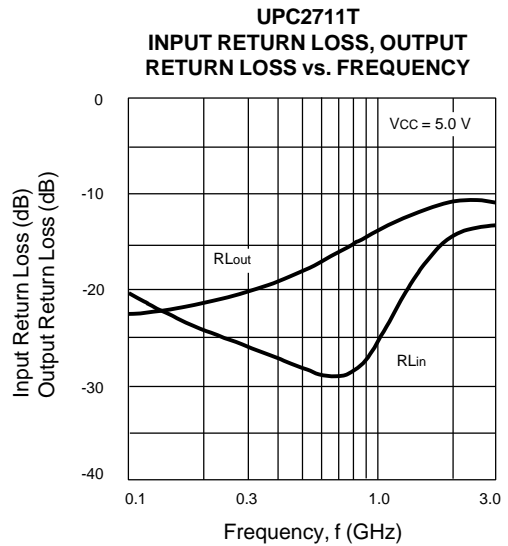
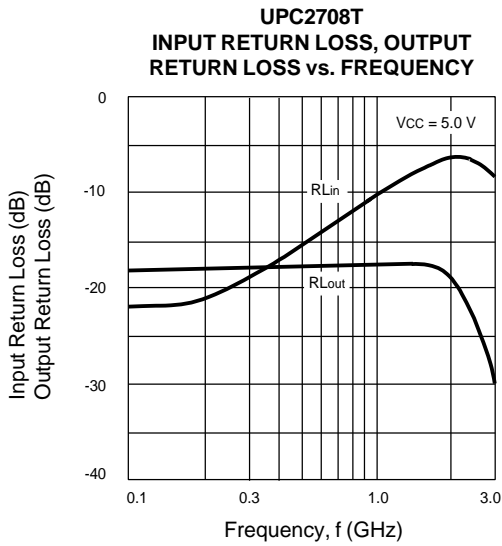

X: Typical SSB Third Order intercept Point

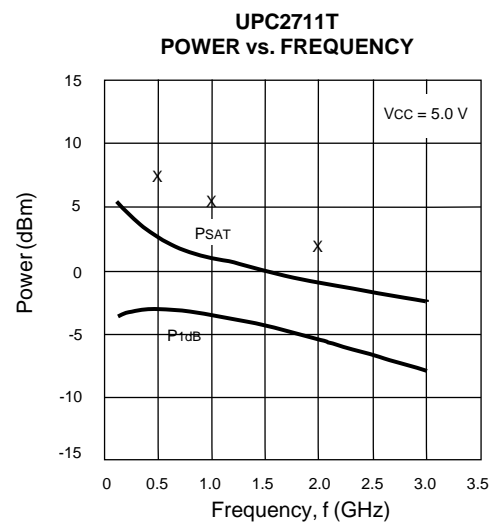

X: Typical SSB Third Order intercept Point

TYPICAL PERFORMANCE CURVES (TA = 25°C)

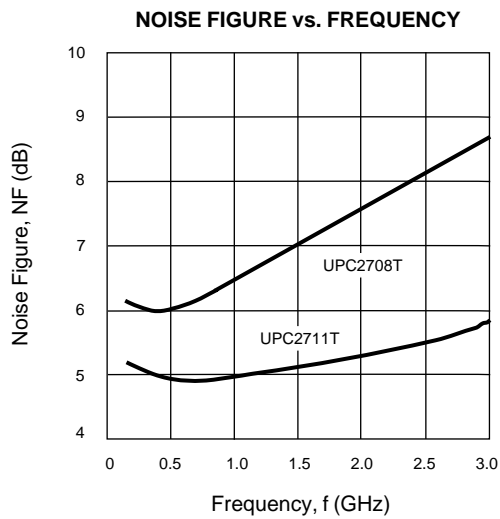
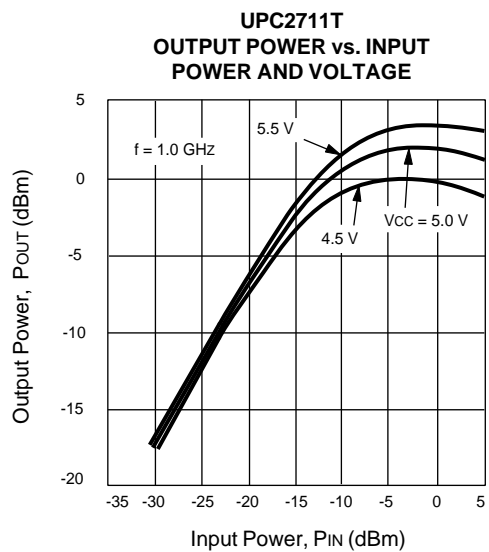
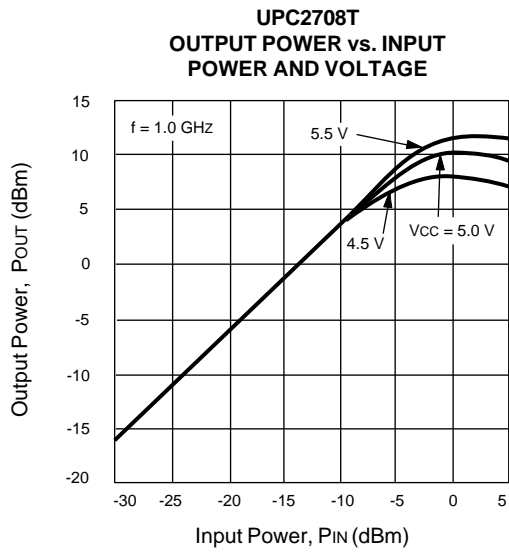
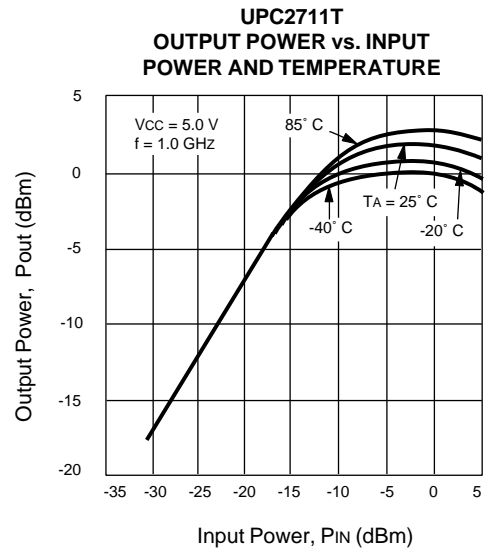
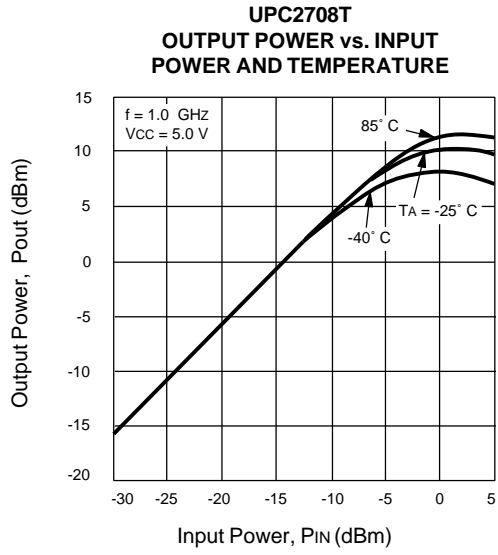

UPC2708T, UPC2711T

TYPICAL SCATTERING PARAMETERS (TA = 25°C)

UPC2708T

Vcc = 5 V, Icc = 26 mA

FREQUENCY GHz	S11		S21		S12		S22		K ¹	S21 (dB)
	MAG	ANG	MAG	ANG	MAG	ANG	MAG	ANG		
0.10	0.040	-3.6	5.1	-3.2	0.073	0.2	0.132	-11.5	1.49	14.2
0.20	0.063	30.7	5.2	-11.6	0.072	-1.3	0.138	-12.1	1.49	14.3
0.30	0.087	41.8	5.2	-18.5	0.071	-3.0	0.139	-13.1	1.50	14.3
0.40	0.112	47.5	5.2	-25.4	0.070	-4.2	0.140	-17.1	1.51	14.3
0.50	0.132	49.4	5.2	-32.3	0.069	-5.6	0.142	-19.8	1.51	14.3
0.60	0.162	49.6	5.2	-38.4	0.068	-5.9	0.144	-21.3	1.52	14.3
0.70	0.187	47.7	5.2	-45.3	0.067	-6.2	0.147	-23.6	1.52	14.3
0.80	0.211	45.7	5.2	-52.3	0.066	-6.6	0.150	-26.1	1.52	14.3
0.90	0.238	44.4	5.2	-59.3	0.065	-6.6	0.153	-28.5	1.52	14.4
1.00	0.265	40.0	5.2	-64.4	0.064	-5.3	0.157	-31.0	1.52	14.4
1.20	0.319	32.0	5.2	-79.1	0.063	-5.3	0.165	-36.1	1.48	14.4
1.40	0.363	23.8	5.2	-94.2	0.061	-5.5	0.171	-43.7	1.48	14.3
1.60	0.404	15.3	5.1	-109.5	0.060	-4.9	0.176	-50.2	1.45	14.2
1.80	0.435	6.9	5.0	-125.6	0.060	-3.7	0.168	-57.3	1.46	13.9
2.00	0.460	-3.4	4.7	-141.1	0.060	-0.4	0.156	-62.5	1.49	13.4
2.20	0.456	-12.6	4.5	-156.6	0.060	-0.4	0.141	-60.3	1.58	13.0
2.40	0.442	-19.9	4.1	-172.5	0.060	-1.8	0.123	-61.6	1.74	12.3
2.60	0.422	-26.5	3.7	172.7	0.060	0.2	0.100	-61.5	1.95	11.4
2.80	0.396	-31.5	3.3	158.9	0.059	0.1	0.077	-61.6	2.26	10.4
3.00	0.365	-35.3	2.9	146.5	0.059	2.0	0.051	-56.7	2.62	9.3

UPC2711T

Vcc = 5 V, Icc = 12 mA

FREQUENCY GHz	S11		S21		S12		S22		K ¹	S21 (dB)
	MAG	ANG	MAG	ANG	MAG	ANG	MAG	ANG		
0.10	0.115	-13.9	4.1	-5.3	0.036	-1.3	0.098	-2.1	3.34	12.3
0.20	0.110	-22.1	4.1	-12.1	0.035	-2.0	0.103	2.7	3.44	12.3
0.30	0.104	-31.2	4.1	-18.3	0.034	-4.8	0.106	4.8	3.54	12.3
0.40	0.096	-41.7	4.2	-24.0	0.033	-5.1	0.116	5.6	3.63	12.4
0.50	0.085	-52.0	4.2	-29.9	0.032	-7.5	0.126	6.6	3.70	12.4
0.60	0.080	-58.8	4.2	-35.6	0.031	-8.9	0.142	4.1	3.82	12.4
0.70	0.071	-74.8	4.2	-41.3	0.030	-10.6	0.150	2.2	3.87	12.6
0.80	0.056	-88.7	4.3	-47.6	0.029	-10.7	0.160	0.5	3.94	12.7
0.90	0.044	-103.9	4.3	-54.2	0.028	-11.4	0.173	-2.6	4.03	12.8
1.00	0.030	-125.2	4.4	-61.0	0.027	-13.2	0.187	-5.3	4.13	12.8
1.20	0.028	149.4	4.5	-74.4	0.024	-11.0	0.211	-13.4	4.47	13.1
1.40	0.060	96.8	4.6	-89.4	0.022	-9.9	0.233	-21.3	4.75	13.2
1.60	0.103	72.8	4.6	-104.8	0.020	-5.6	0.250	-30.2	5.11	13.2
1.80	0.150	53.6	4.5	-121.3	0.019	7.0	0.259	-38.4	5.38	13.1
2.00	0.201	38.3	4.5	-136.9	0.020	20.8	0.264	-46.0	5.08	13.0
2.20	0.244	26.8	4.3	-152.6	0.021	28.7	0.261	-53.5	4.94	12.6
2.40	0.284	17.2	4.1	-167.4	0.026	29.9	0.244	-59.5	4.16	12.2
2.60	0.318	8.4	3.8	178.2	0.031	33.7	0.222	-62.9	3.70	11.6
2.80	0.347	1.8	3.5	165.2	0.034	31.7	0.198	-62.8	3.58	11.0
3.00	0.369	-3.9	3.3	152.4	0.039	29.9	0.175	-58.8	3.35	10.4
3.20	0.386	-8.4	3.1	140.5	0.043	27.3	0.163	-49.0	3.25	9.7
3.40	0.397	-11.9	2.8	129.0	0.048	24.7	0.162	-37.3	3.14	9.1

Note:

1. K factor calculations:

$$K = \frac{1 + |\Delta|^2 - |S_{11}|^2 - |S_{22}|^2}{2 |S_{12} S_{21}|}, \Delta = S_{11} S_{22} - S_{21} S_{12}$$

UPC2708T, UPC2711T

EQUIVALENT CIRCUIT

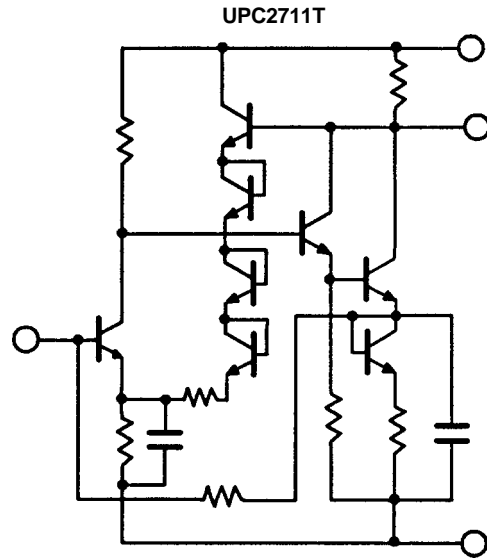
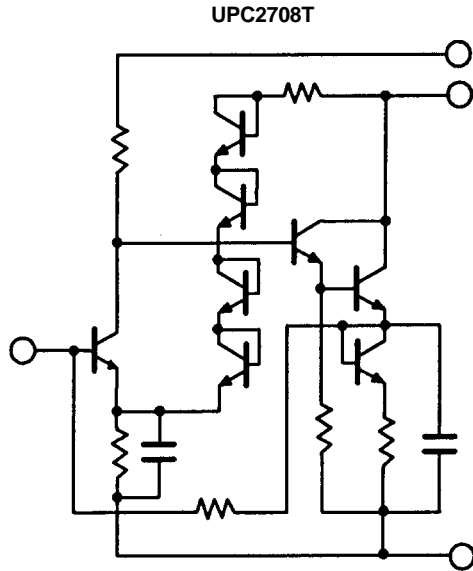

OUTLINE DIMENSIONS (Units in mm)

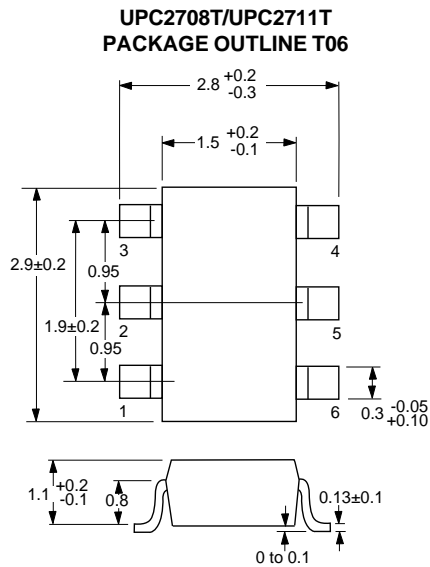

Note: All dimensions are typical unless otherwise specified.

ORDERING INFORMATION

PART NUMBER	QTY
UPC2708T-E3	3K/Reel
UPC2711T-E3	3K/Reel

*Embossed Tape, 8 mm wide.

LEAD CONNECTIONS

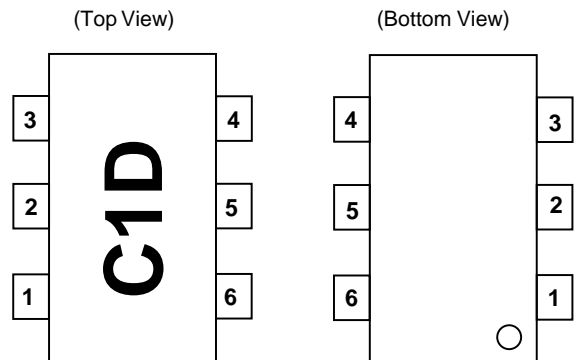

- 1. INPUT 4. OUTPUT
- 2. GND 5. GND
- 3. GND 6. Vcc

Note: Package Markings:
C1D - UPC2708T
C1G - UPC2711T

RECOMMENDED P.C.B. LAYOUT (Units in mm)

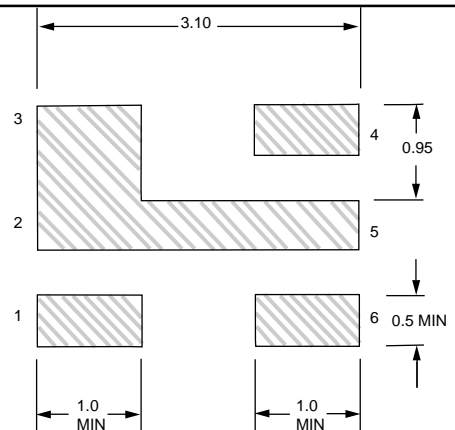

EXCLUSIVE AGENT FOR **NEC Corporation** RF & MICROWAVE SEMICONDUCTOR PRODUCTS - U.S. & CANADA